

Art. 867 Slide nut with threaded pin for CorSTRUT

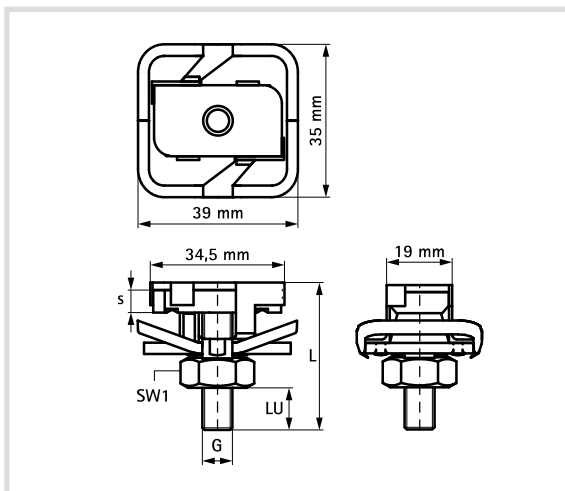

Technical specifications and advantages

- Slide nut with threaded pin, square washer and plastic spring
- Made with S235JR steel
- Galvanised
- Spring in POM (polyoxymethylene), green
- With a plastic spring that keeps the piece fixed in the desired position until final tightening
- Possibility of height adjustment of the pin
- Tested for fire resistance



Code	G	L [mm]	s [mm]	SW1 [mm]	LU [mm]	Fa,z [N]
8670840	M8	40	6,0	13	16	6000
8670860	M8	60	6,0	13	36	6000
8670880	M8	80	8,0	13	56	6000
8670810	M8	100	8,0	13	76	6000
8671040	M10	40	8,0	17	12	6000
8671060	M10	60	8,0	17	32	6000
8671080	M10	80	8,0	17	52	6000
8671240	M12	40	10,0	19	10	10000
8671260	M12	60	10,0	19	30	10000
8671280	M12	80	10,0	19	50	10000

