

Assembly Instruction

FLAMRO FM I Combi Seal EN

according to ETA-17/0468

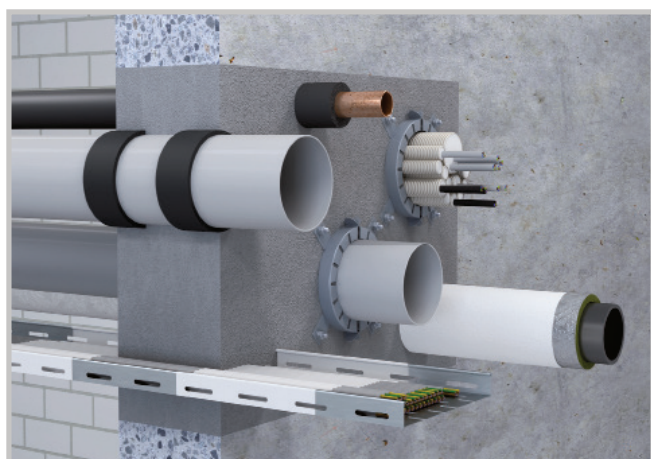

Content

Target audience, usage of assembly instruction, safety information	2
Components	3
Application field (Component strength, insulation strength and distances)	4
Approved assignments and classifications	4
Approved assignment – Cables	4
Approved assignment – Conduits	5
Approved assignment – Combustible pipes	5
Approved assignment – Non-combustible pipes	6
Approved assignment – Copper pipes with Armaflex Protect	6
Approved assignment – Waveguides	7
Distance regulations	9
Applied products	10
Arrangement of the first support (backings)	11
Fire protection measures for walls and floors	11
Penetration of cables / cable bundles / cable trays and ladders	12
Penetration of conduits	14
Penetration of combustible pipes with Variant N II A	17
Penetration of combustible pipes with Variant N III wrap	19
Penetration of non-combustible pipes with Rohre	21
Penetration of copper pipes with Armaflex Protect	23
Penetration of waveguides	24
Assembly steps	25
Declaration of performance	

Assembly Instruction

FLAMRO FM I Combi Seal EN

according to ETA-17/0468

Target audience

This assembly instruction is addressed exclusively to trained experts on fire technology.

Usage of assembly instruction

- Please read through the lot of this assembly instruction carefully prior to work start. Regard in particular the following safety information.
- The holder of assessment assumes no liability for damages which are caused by disregard for this assembly instruction.
- Graphic depictions serve as examples only. Assembly results may vary visually.





Safety information

For processing of partition components, please regard the safety data sheets.



Protection and hygiene measures:

- Observe the usual precautions when handling chemicals. Wash hands before work breaks and immediately after handling the product. Avoid contact with skin, eyes and clothing. Take off stained or soaked clothes or soaked clothes immediately.
- Eye wash with clean water (EN 15154).
- Wear closed work clothing.

	Respiratory protection - Dust mask When exposure limit is exceeded (e.g. possible when turning on), use particle-filtering half mask FFP 1 (white).
	Hand protection - Protective gloves Use waterproof, abrasion- and alkali-resistant nitrile gloves. Different requirements can result depending on application. Therefore observe additional recommendations by the protective gloves' manufacturer.
	Eye protection – Use safety goggles
	Body protection – Use protective work wear

Safety information for installation of floor partitions

- The area beneath the floor partition is to be blocked during construction work and during cure time (28 days) (barrier tape and warning sign: beware of potentially falling object, do not enter this area, construction work in floor component opening).
- The contractor for the manufacture of floor insulations must inform the client in writing (for onward transmission to the building contractor or his representative), that fire protection insulation in floors must be secured with appropriate measures against burdens, especially the entering by trespassers (e.g. through fencing or grating covers).

Assembly Instruction

FLAMRO FM I Combi Seal EN

according to ETA-17/0468

Components

Rigid walls

The wall must have a minimum thickness of ≥ 100 mm and consist of concrete, aerated concrete or masonry with a minimum raw density of 550 kg / m^3 . The wall shall be classified in accordance to EN 13501 - 2 for the required fire resistance period.

For walls with a thickness of ≤ 170 mm, a min. 100 mm thick packing made of non-combustible fire protection building panels (e.g. calcium silicate panels) is to be arranged on one side of the seal opening, so that a component thickness of 170 mm is given.

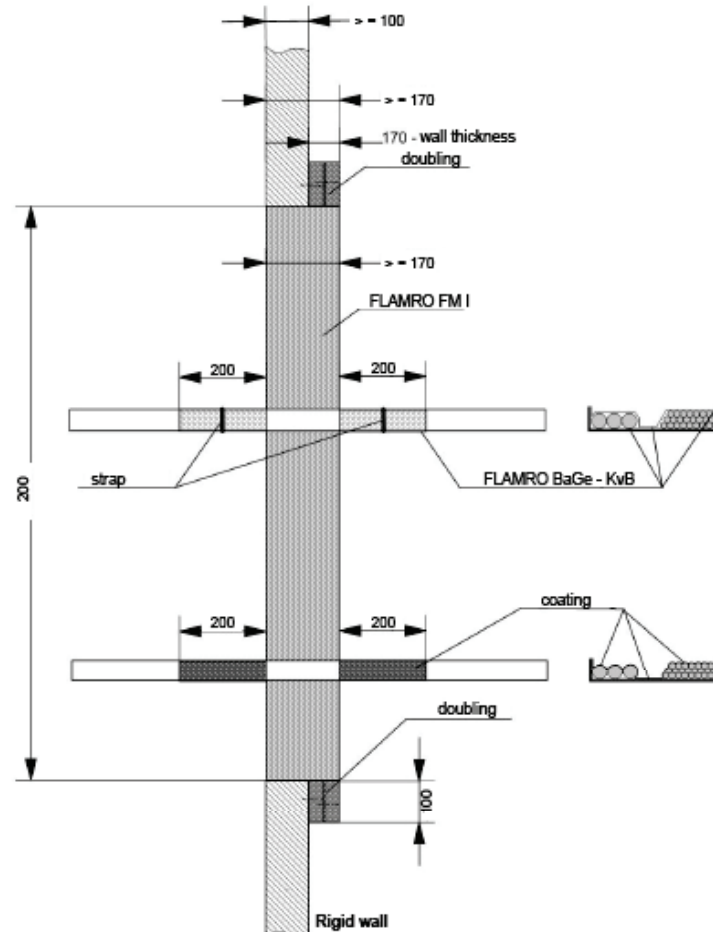

Rigid floor

The floor must have a minimum thickness of ≥ 150 and consist of concrete or aerated concrete with a minimum raw density of 550 kg / m^3 . The rigid floor shall be classified in accordance with EN 13501 - 2 for the required fire resistance period.

Penetration seals in floors are to be secured with fences or grating against burdens or the entering of trespassers.

The required technical fire protection measures are depicted on the following pages and also apply for subsequent installations.

Assembly Instruction

FLAMRO FM I Combi Seal EN

according to ETA-17/0468

Application field

Identifier	Wall	Floor
Thickness of the component	≥ 100 mm	≥ 150 mm
Thickness of the penetration seal	≥ 170 mm	≥ 150 mm
Maximal size of component opening (width x height) (wall) Maximal size of component opening (width x height) (floor)	1200 x 2000 mm (≤ 2.40 m ²)	max. seal opening: 1000 x 1200 mm (length can be increased arbitrarily, as long as the ratio between perimeter and surface is not smaller than the approved penetration seal, viz. U/A = 3.66)
Distance to other cable/pipe penetrations	≥ 200 mm	≥ 200 mm
Distance to other openings or installations	≥ 200 mm	≥ 200 mm

Approved assignments and classifications

Cable - wall and floor					
Image	Assignment	Additional fire protection measures	E	I	Pipe end configuration
	Sheathed cables Ø ≤ 80 mm	FLAMRO BaGe - KVB 200 x 1 mm (L x TH) on both sides wrapped around cable racks / ladders and cables or BC fire protection paint 200 x 1 mm (L x TH) coated on both sides of cable trays / ladders and cables	120	120	-
	Cable bundles up to Ø ≤ 100 mm with single cables Ø ≤ 21 mm		120	120	-
	Conduits made of plastic or steel Ø ≤ 16 mm		120	120	U/U

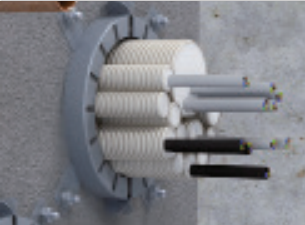
Conduits - wall and floor					
Image	Assignment	Additional fire protection measures	E	I	Pipe end configuration
	Conduits ≤ 40 mm up to bundle diameter of 110 mm diameter of single cables ≤ 27 mm	Wall: FLAMRO Variant N II A pipe collar on both sides Floor: FLAMRO Variant N II A pipe collar underneath the floor	120	120	C/C

Assembly Instruction

FLAMRO FM I Combi Seal EN

according to ETA-17/0468

Combustible pipes - wall and floor					
Image	Assignment	Additional fire protection measures	E	I	Pipe end configuration
	PP pipe ≤ 110 mm	Wall: FLAMRO Variant N III wrap collar on both sides Floor: FLAMRO Variant N III wrap collar underneath the floor	120	120	U/U
	PE pipe ≤ 110 mm		120	120	U/U
	PVC pipe ≤ 110 mm		120	120	U/U
	PP pipe ≤ 110 mm	FLAMRO Variant N III wrap 2 layers (≤ 75 mm) or 3 layers (> 75 mm and ≤ 110 mm) through component reveal and flush with both sides of the wall, for floors only underneath the floor	120	120	U/C
	PE pipe ≤ 110 mm		120	120	U/C
	PVC pipe ≤ 110 mm		120	120	U/C
Non-combustible pipes - wall and floor					
Image	Assignment	Additional fire protection measures	E	I	Pipe end configuration
	Copper pipe ≤ 88.9 mm	Rockwool Klimarock mats 500 x 40 mm (L x TH) on both sides or through component reveal + IM bandage, 250 x 1 mm (L x TH) on both sides	120	120	C/U
	Steel pipe ≤ 168.3 mm		120	120	C/U
Copper pipes with Armaflex Protect pipe tube - wall					
Image	Assignment	Additional fire protection measures	E	I	Pipe end configuration
	Copper pipe ≤ 88.9 mm	Armaflex Protect Pipe tubes, thickness 25 mm, over total length and through component reveal	120	90	C/U

Assembly Instruction

FLAMRO FM I Combi Seal EN

according to ETA-17/0468

Copper pipes with Armaflex Protect pipe tube - floor					
Image	Assignment	Additional fire protection measures	E	I	Pipe end configuration
	Copper pipe ≤ 22 mm	Armaflex Protect pipe tubes, thickness 25 mm, over total length and through the seal opening	120	90	C/U
	Copper pipe ≤ 88.9 mm		120	60	C/U

Conduits - wall and floor					
Image	Assignment	Additional fire protection measures	E	I	Pipe end configuration
	3/8" HELIFLEX® Air-Dielectric Coaxial Cable	Rockwool Klimarock mats, 400 x 40 mm (L x TH) on both sides	120	120	U/U
	1-1/8" HELIFLEX® Air-Dielectric Coaxial				
	1-5/8" HELIFLEX® Air-Dielectric Coaxial Cable				
	FLEXWELL® Standard Elliptical Waveguide E380				
	FLEXWELL® Standard Elliptical Waveguide E38				

Assembly Instruction

FLAMRO FM I Combi Seal EN

according to ETA-17/0468

Distance regulations for rigid walls and floors

Cable / cable bundle / cable trays, ladders		Distance
	Sideways distance to component reveal	≥ 0 mm
	Side by side distance	≥ 0 mm
	Lower / back distance to component reveal	≥ 0 mm
	Upper / front distance to component reveal	≥ 20 mm
	One below the other distance	≥ 20 mm
	Distance to combustible pipes	≥ 20 mm
	Distance to non-combustible pipes	≥ 0 mm
	Distance pipes among each other (for non-combustible and combustible pipes)	≥ 0 mm
Conduits $\varnothing \leq 16$ mm, made of steel or plastic		
	Side by side distance	≥ 0 mm

Assembly Instruction

FLAMRO FM I Combi Seal EN

according to ETA-17/0468

Table of minimum distances from component reveal or components among each other

		Distances wall (mm)											
from	to	component reveal				from	to	cable		pipes		Conduits	Waveguides
		above	below	right	left			cable	cable trays	com-bustible	non-com-bustible		
Cable		20	0	0	0	Cable		0	0	20	0	100	100
Cable trays		20	0	0	0	Cable trays		0	0	20	0	100	100
Combustible pipes		0	0	0	0	Combustible pipes		20	20	0	0	100	100
Non-combustible pipes		0	0	0	0	Non-combustible pipes		0	0	0	100	100	100
Conduits		100	100	50	50	Conduits		100	100	100	100	100	100
Waveguides		100	0	0	0	Waveguides		100	100	100	100	100	100





		Distances floor (mm)											
from	to	component reveal				from	to	cable		pipes		Conduits	Waveguides
		above	below	right	left			cable	cable trays	com-bustible	non-com-bustible		
Cable		0	0	0	0	Cable		0	0	0	0	100	100
Cable trays		0	0	0	0	Cable trays		0	0	0	0	100	100
Combustible pipes		0	0	0	0	Combustible pipes		0	0	0	0	100	100
Non-combustible pipes		0	0	0	0	Non-combustible pipes		0	0	0	0	100	100
Conduits		0	0	0	0	Conduits		100	100	100	100	60	100
Waveguides		20	0	0	0	Waveguides		100	100	100	100	100	100

Assembly Instruction

FLAMRO FM I Combi Seal EN

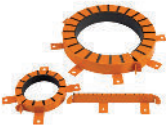
according to ETA-17/0468

Applied products

Image	Article identifier		Art-No.
	FLAMRO FM I Fire protection mortar 10 kg		90910
	FLAMRO FM I Fire protection mortar 20 kg		90920
	FLAMRO Variant N II A Fire protection collar, up to Ø 110 mm		
	FLAMRO Variant N III wrap	12500 x 50 x 2 self-adhesive	15512
		12500 x 50 x 2 not self-adhesive incl. assembly adhesion strips	15012
	FLAMRO BaGe cable bandage - KVB, 5200 x 250 mm		31005
	BC Fire protection paint 6 kg 15 kg 22.5 kg		20906 20915 20922
	Identification sign		14000

Assembly Instruction

FLAMRO FM I Combi Seal EN

according to ETA-17/0468

Arrangement of the first support (backings)

Supports/Backings of the installations in front of the wall insulation must consist of essentially non-combustible components and be arranged with a distance according to the following overview.

Installations	Wall	Floor
Cables, Cable trays and ladders	≤ 200 mm on both sides	≤ 250 mm from above
Combustible pipes	≤ 500 mm on both sides	≤ 500 mm from above
Non-combustible pipe	≤ 500 mm on both sides	≤ 600 mm from above
Conduits	≤ 500 mm on both sides	≤ 250 mm from above
Waveguide	≤ 300 mm on both sides	≤ 250 mm from above

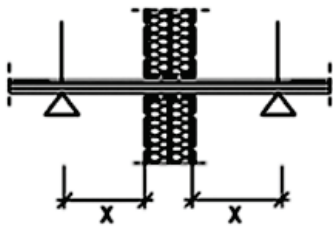

Assembly Instruction

FLAMRO FM I Combi Seal EN

according to ETA-17/0468

Fire protection measures in walls and floors

Penetration of cables

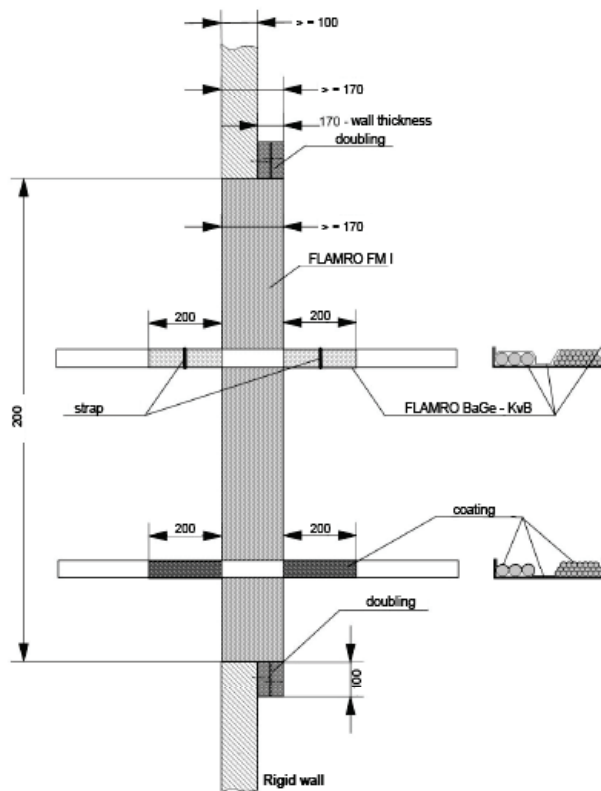

Image left:

Penetration of cables

Wall

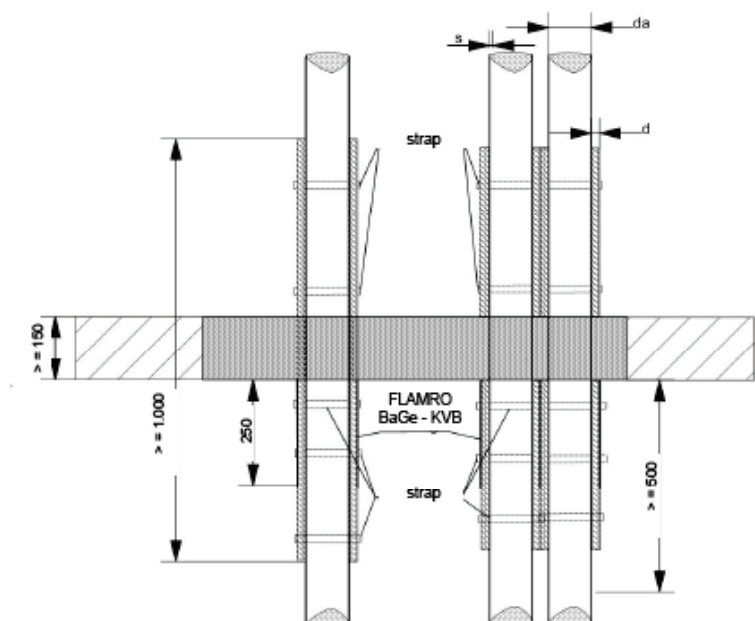

Image right:

Penetration of cables

Floor

Assembly Instruction

FLAMRO FM I Combi Seal EN

according to ETA-17/0468

Fire protection measures in walls and floors

Penetration of conduits

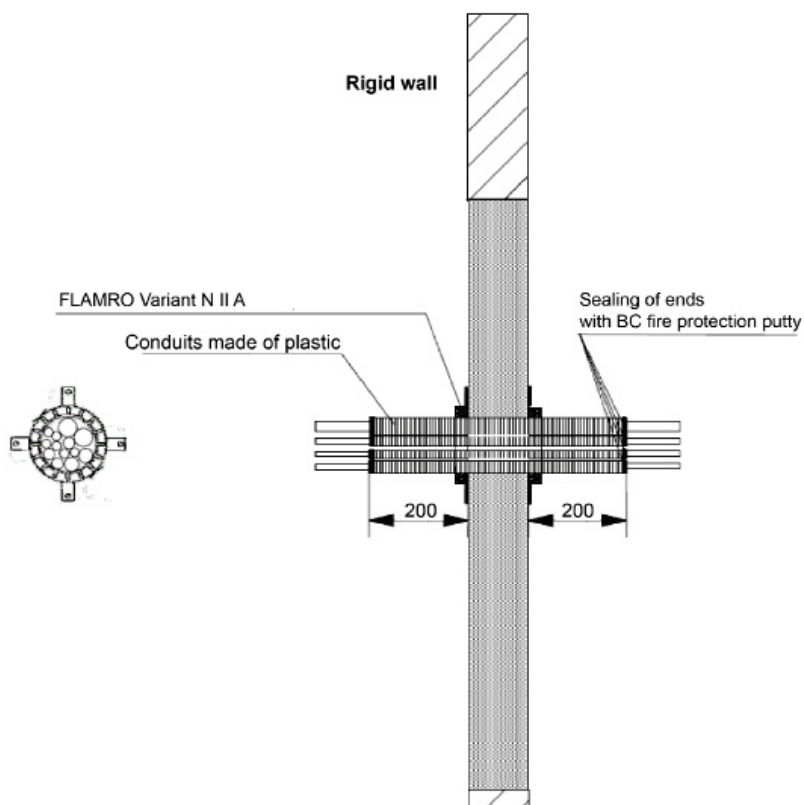

Upper image:

Penetration of conduits

Wall

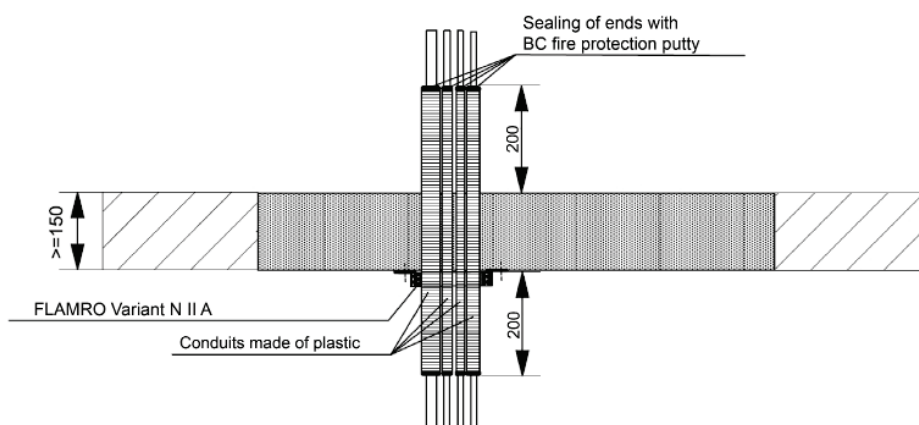

Lower image:

Penetration of conduits

Floor

Assembly Instruction

FLAMRO FM I Combi Seal EN

according to ETA-17/0468

Fire protection measures in walls and floors

Penetration of conduits (made of plastic)

FLAMRO Variant N II A	Pipe collar					Layer height intumescent strip	Thickness of Fire protection insertion	Number of mounting points	Mounting inner drilling hole-Ø
	inner Ø	outer Ø	ring width	metal thickness	height				
32/34	36	50	7.0	0.6	26.0	25.4	6.4 ± 0.5	2	6.0
40/42	44	58	7.0	0.6	26.0	25.4	6.4 ± 0.5	2	6.0
50/52	54	68	7.0	0.6	26.0	25.4	6.4 ± 0.5	2	6.0
63/65	67	94	13.5	0.6	26.0	25.4	12.8 ± 1.0	4	9.0
75/77	79	106	13.5	0.6	26.0	25.4	12.8 ± 1.0	4	9.0
90/92	94	132	18.3	1.1	26.6	25.4	17.1 ± 1.0	4	9.0
110/112	114	155	20.5	1.1	26.6	25.4	19.2 ± 1.5	4	9.0

all measures in [mm]

Conduits (made of plastic)					
Identifier	Outer diameter (mm)	Inner diameter (mm)	Wave height (mm)	Pipe wall thickness (mm)	
				Pipe on the inside (mm)	Coating (mm)
DN 16	16	10.9	2.5 - 2.6	0.5	0.3
DN 20	20	14.2	2.8		
DN 25	25	18.6	3.2		
DN 32	32	24.3	3.8 - 3,9	0.6	
DN 40	40	31.3	4.3 - 4.4		

Assembly Instruction

FLAMRO FM I Combi Seal EN

according to ETA-17/0468

Fire protection measures in walls and floors

Penetration of combustible pipes with FLAMRO Variant N II A

Upper image:

Penetration of combustible pipes
with FLAMRO Variant N II A
Wall

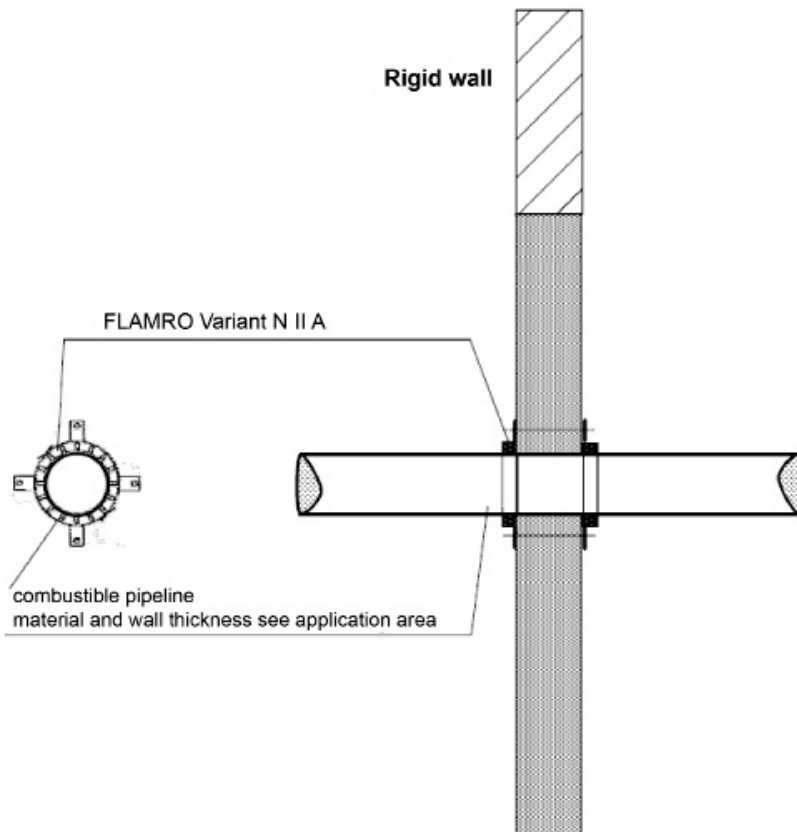

Lower image:
Penetration of combustible pipes
with FLAMRO Variant N II A
Floor

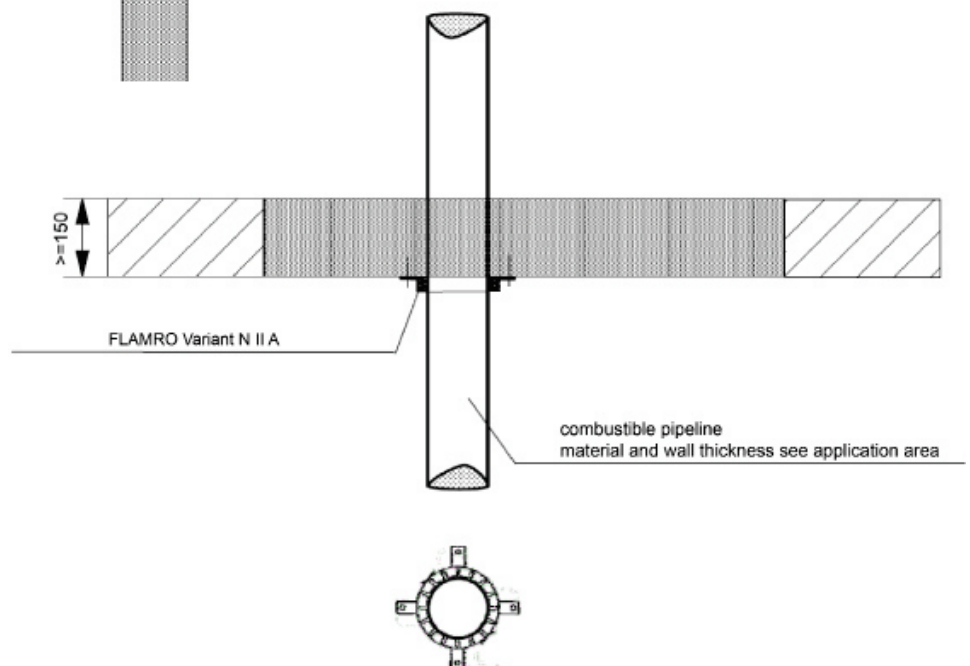

Assembly Instruction

FLAMRO FM I Combi Seal EN

according to ETA-17/0468

Fire protection measures in walls and floors

Penetration of combustible pipes with FLAMRO Variant N II A

FLAMRO Variant N II A	Pipe collar					Layer height intumescent strip	Thickness of Fire protection insertion	Number of mounting points	Mounting inner drilling hole-Ø
	inner Ø	outer Ø	ring width	metal thickness	height				
32/34	36	50	7.0	0.6	26.0	25.4	6.4 ± 0.5	2	6.0
40/42	44	58	7.0	0.6	26.0	25.4	6.4 ± 0.5	2	6.0
50/52	54	68	7.0	0.6	26.0	25.4	6.4 ± 0.5	2	6.0
63/65	67	94	13.5	0.6	26.0	25.4	12.8 ± 1.0	4	9.0
75/77	79	106	13.5	0.6	26.0	25.4	12.8 ± 1.0	4	9.0
90/92	94	132	18.3	1.1	26.6	25.4	17.1 ± 1.0	4	9.0
110/112	114	155	20.5	1.1	26.6	25.4	19.2 ± 1.5	4	9.0

all measures in [mm]

Assembly Instruction

FLAMRO FM I Combi Seal EN

according to ETA-17/0468

Application area PP pipes with pipe end configuration UU

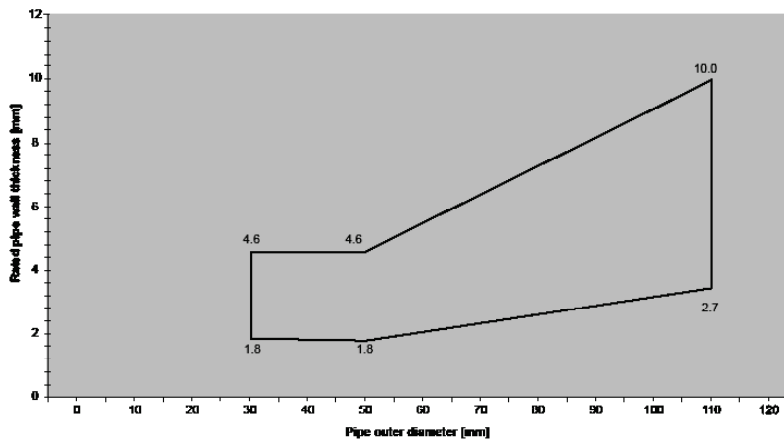

Application area PVC-U pipes with pipe end configuration UU

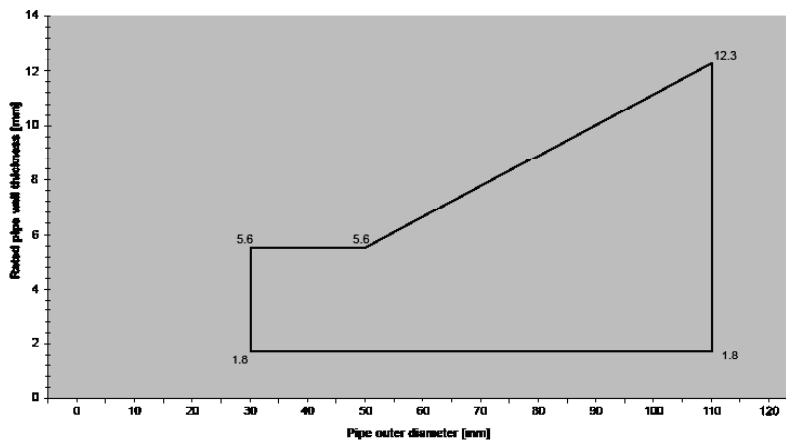

Application area PP pipes with pipe end configuration UU

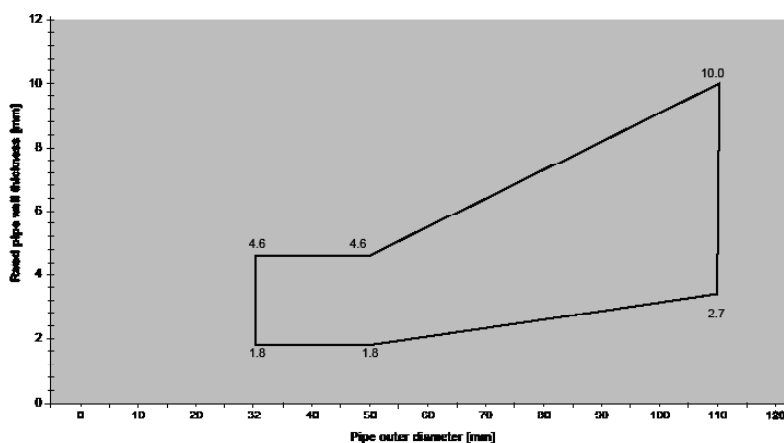

Assembly Instruction

FLAMRO FM I Combi Seal EN

according to ETA-17/0468

Fire protection measures in walls and floors

Penetration of combustible pipes with IWM III

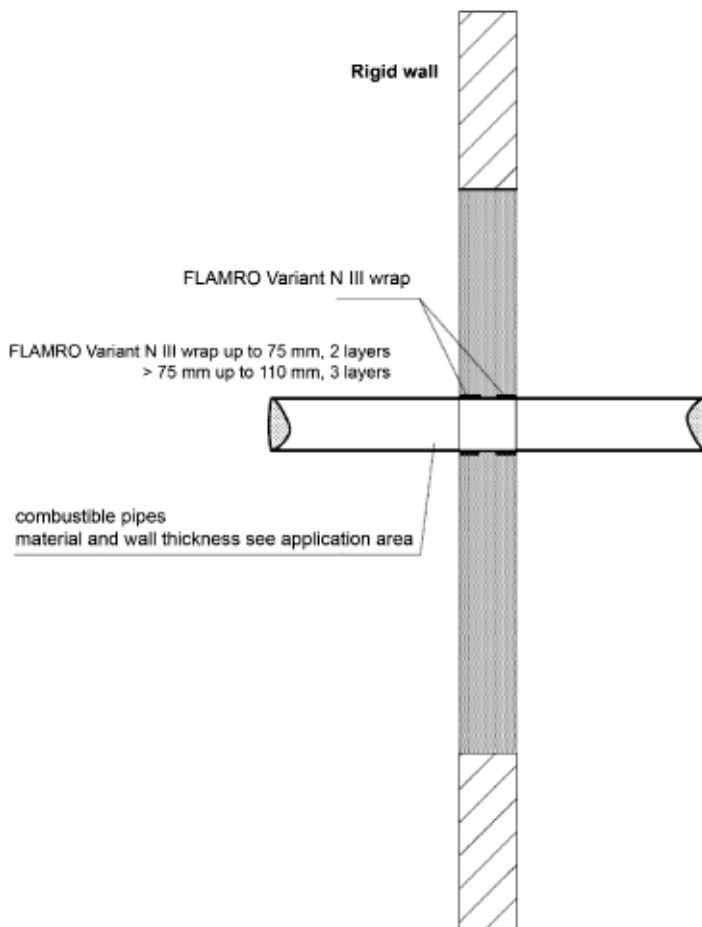

Upper image:

Penetration of combustible pipes with FLAMRO Variant N III wrap Wall

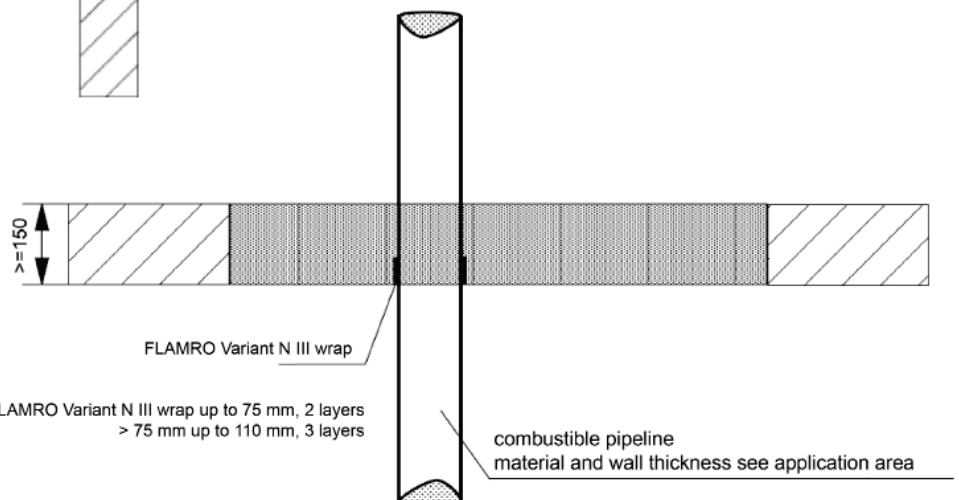

Lower image:

Penetration of combustible pipes with FLAMRO Variant N III wrap Floor

Assembly Instruction

FLAMRO FM I Combi Seal EN

according to ETA-17/0468

PVC-U pipes insulated with FLAMRO Variant N III wrap for construct barriers and insulation thickness of 120 min

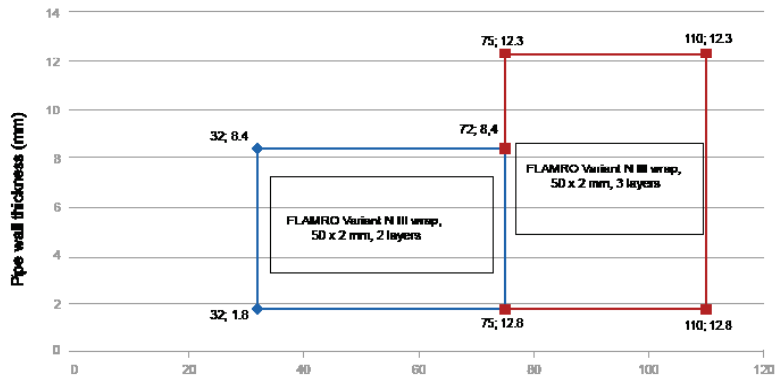

PE-HD pipes insulated with FLAMRO Variant N III wrap strap for construct barriers and insulation thickness of 120 min

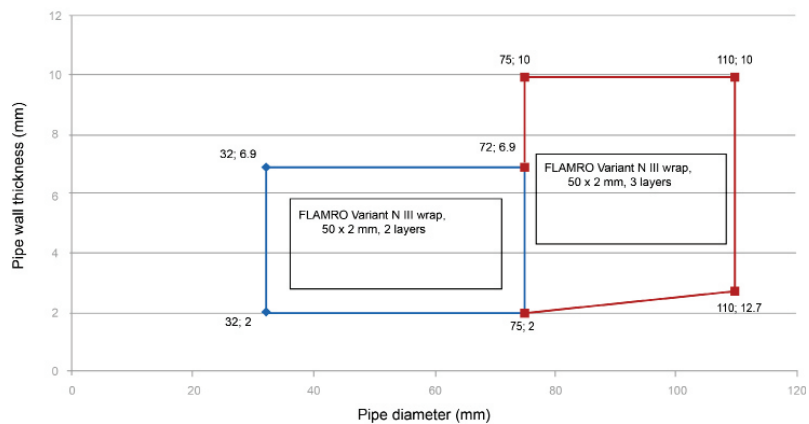

PP pipes insulated with FLAMRO Variant N III wrap for construct barriers and insulation thickness of 120 min

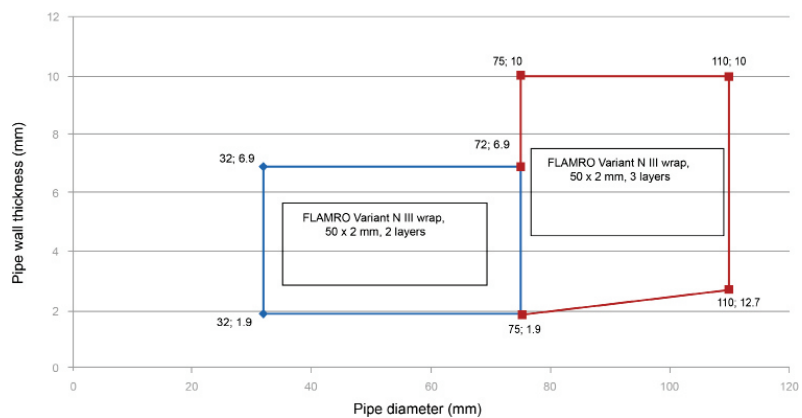

Assembly Instruction

FLAMRO FM I Combi Seal EN

according to ETA-17/0468

Fire protection measures in floors and walls

Penetration of non-combustible pipes

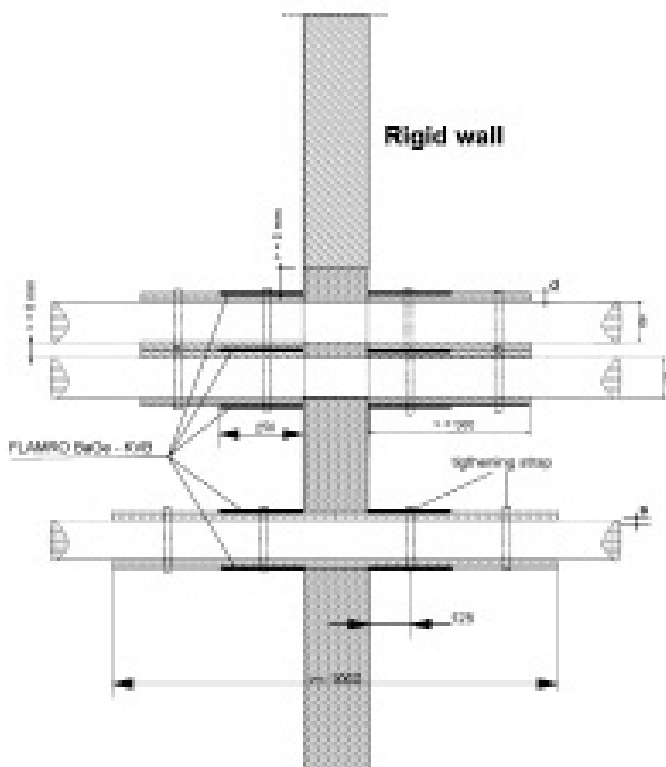

Upper image:
Penetration of
non-combustible pipes
Wall

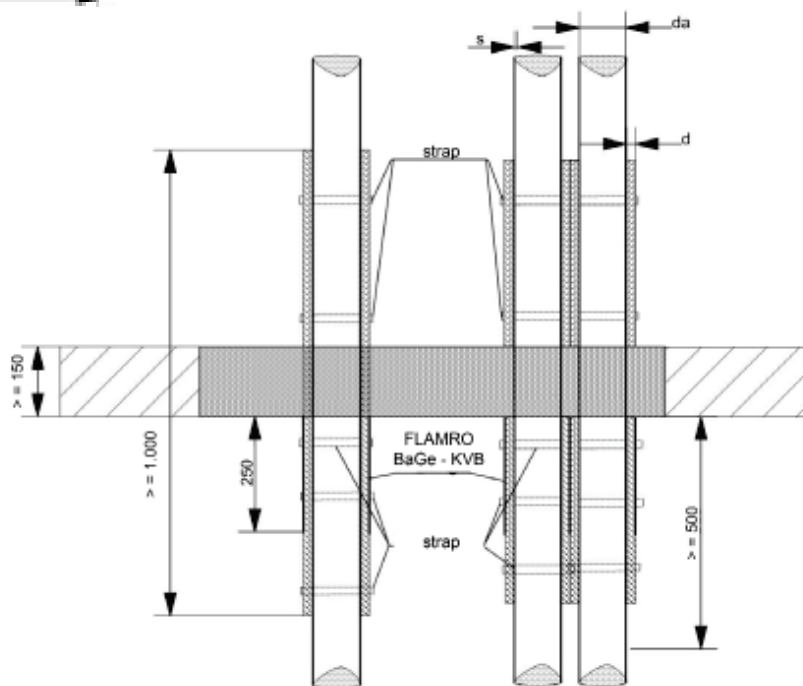

Lower image:
Penetration of
non-combustible pipes
Floor

Assembly Instruction

FLAMRO FM I Combi Seal EN

according to ETA-17/0468

Application area non-combustible pipes with pipe end closure C/U

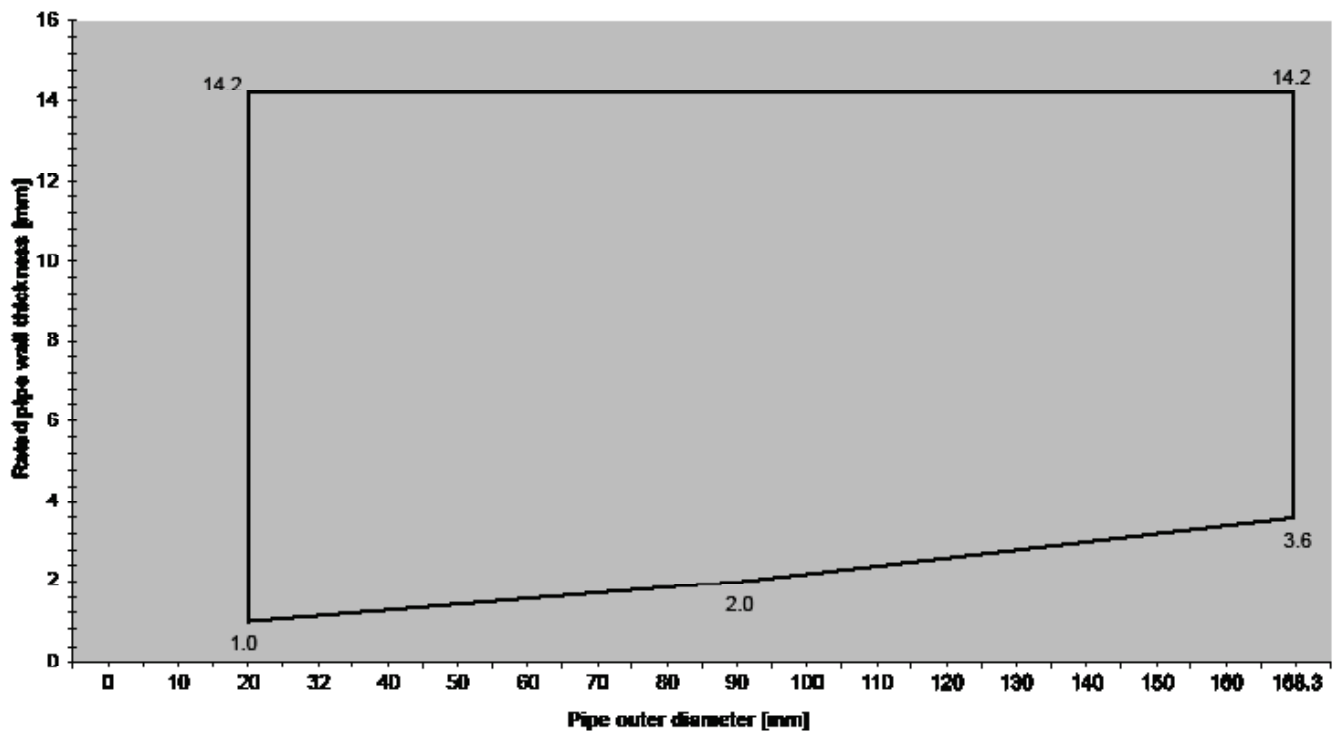

Assembly Instruction

FLAMRO FM I Combi Seal EN

according to ETA-17/0468

Fire protection measures in walls and floors

Penetration of copper pipes with Armaflex Protect

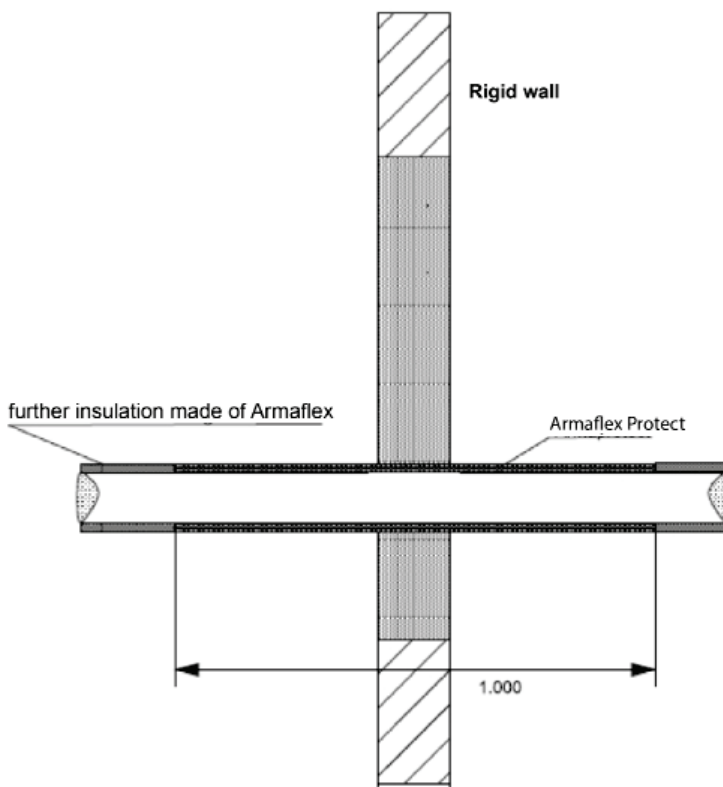

Upper image:
Penetration of copper pipes
with Armaflex Protect
Wall

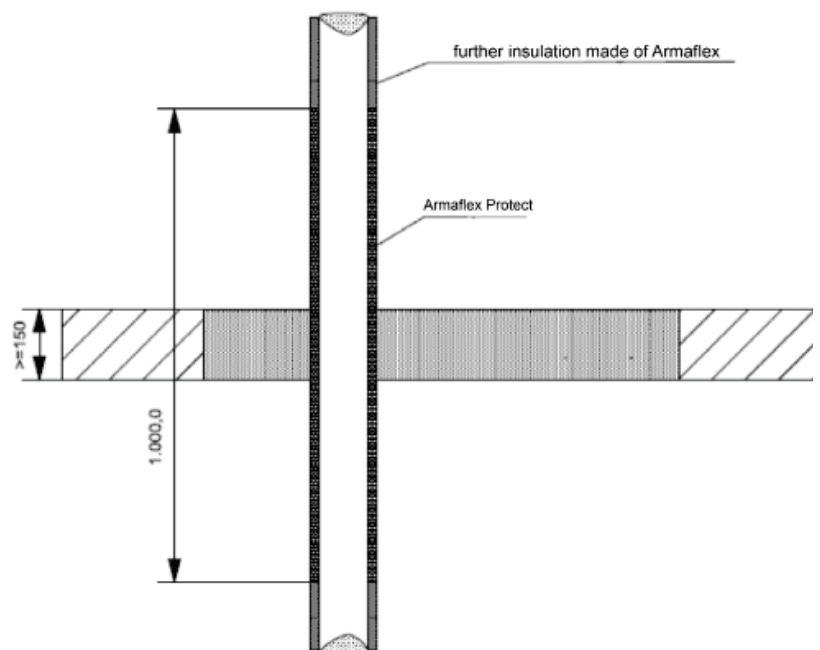

Lower image:
Penetration of copper pipes
with Armaflex Protect
Floor

Assembly Instruction

FLAMRO FM I Combi Seal EN

according to ETA-17/0468

Fire protection measures in walls and floors

Penetration of copper pipes with Armaflex Protect

Wall

Wall: Copper and steel pipes insulated with Armaflex protect pipe tubes for construct barriers and insulation thickness of 90 mm

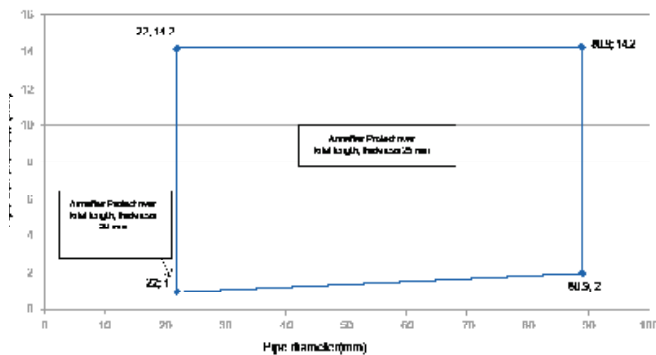

for construct barriers and insulation thickness of 120 mm

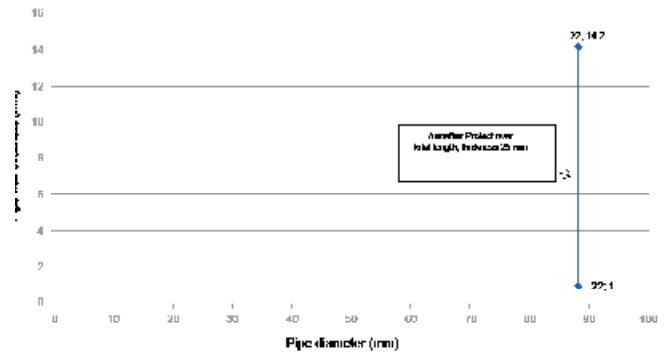

Floor

Wall: Copper and steel pipes insulated with Armaflex protect pipe tubes for construct barriers and insulation thickness of 60 mm

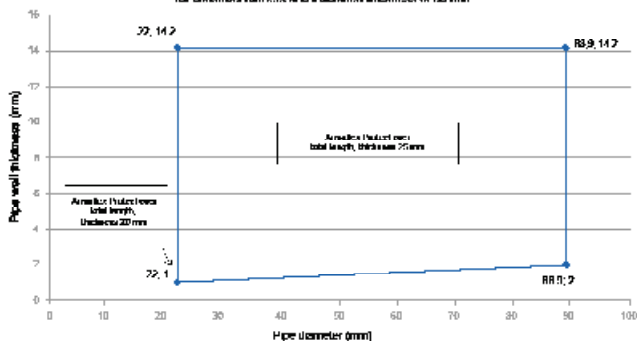

Floor: Copper and steel pipes insulated with Armaflex protect pipe tubes for construct barriers and insulation thickness of 120 mm

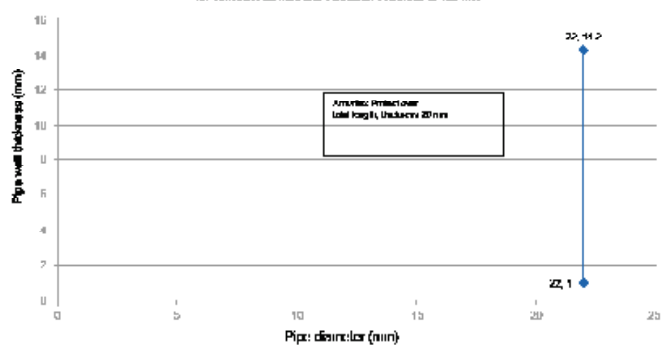

Assembly Instruction

FLAMRO FM I Combi Seal EN

according to ETA-17/0468

Fire protection measures in walls and floors

Penetration of waveguides

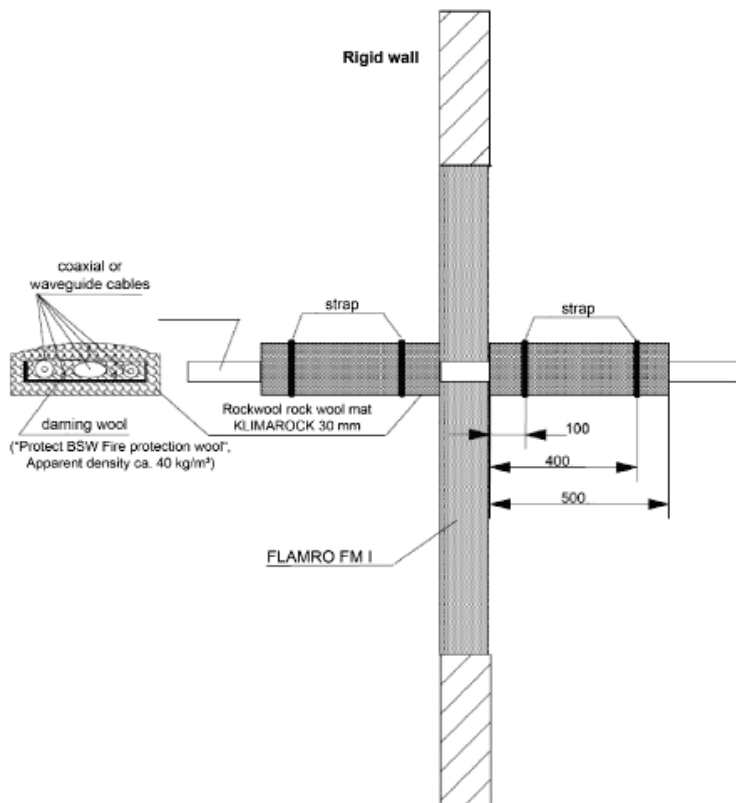

Upper image:
Penetration of waveguides
Wall

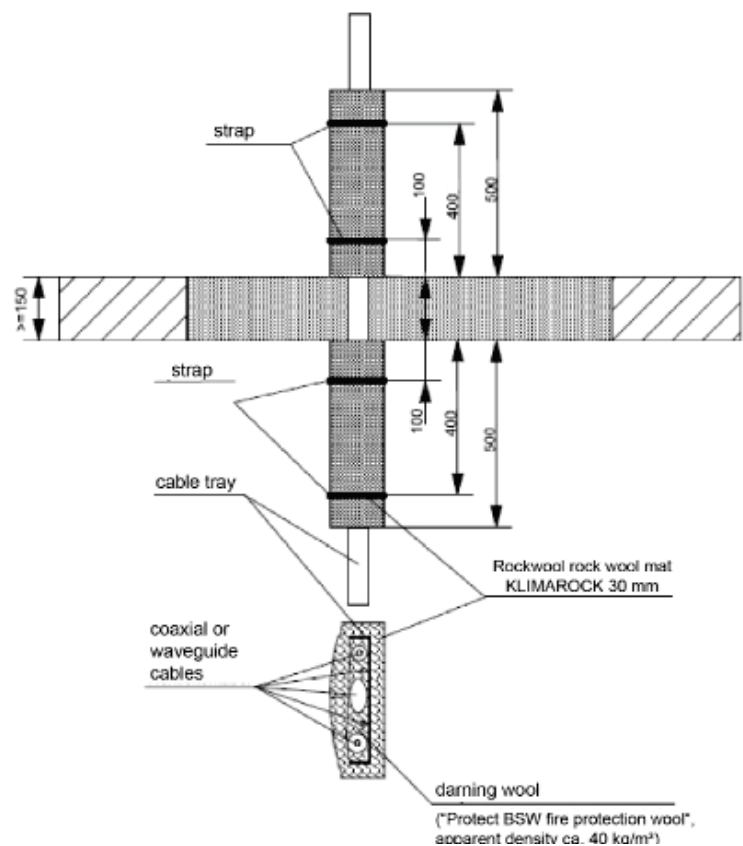

Lower image:
Penetration of waveguides
Floor

Assembly Instruction

FLAMRO FM I Combi Seal EN

according to ETA-17/0468

Assembly instruction



Clean the aperture and remove all loose parts. If necessary, cover floor with suitable materials. Check mounting points of installations on wall or floor (see -Arrangement of the first support (backings)-).



Mix FM I fire protection mortar with water (20 kg bag with ca. 6 litres, 10 kg bag with ca. 3 litres)

Fill a mixing container with water and add the mortar.

Mix thoroughly with a mixing paddle. After a gauging period of ca. 4 - 5 minutes, mix thoroughly one more time.

Observe the safety information!

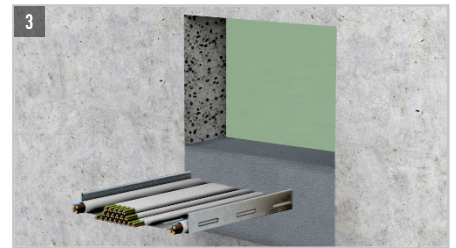

Floor penetration seals and larger wall penetration seals need formwork. Soak absorptive surfaces of the building component with water.



Insert sealing mass so that it creates a firm and dense connection to the building component (seal thickness ≥ 17 cm for wall penetrations and 15 cm for floor penetrations). Make sure to fill gaps and gussets completely.



After respective setting, smooth the surfaces with a paddle and fix potential shrinkage cracks completely. The same applies for areas after removing the formwork supports.

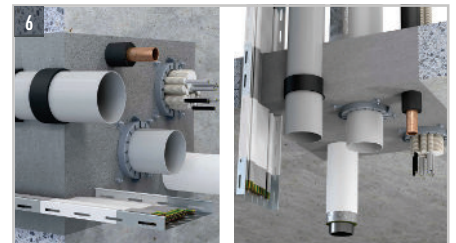

The installations receive the additional fire protection measures (see -Fire protection measures in walls and floors-).

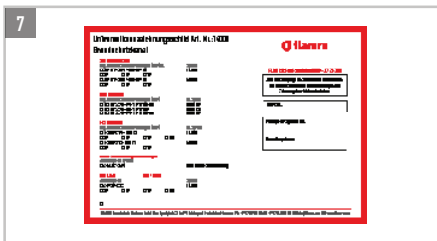

Finally apply the label and clean work place.